

Vasario™

Standard Duty Cash Drawer Series



APG® CASH DRAWER



APG CASH DRAWER®

APG's Vasario standard duty cash drawers are truly "best of class". Each member of the Vasario cash drawer family is competitively priced and includes features found in more expensive cash drawers.

Electronically activated Vasario cash drawers will provide over one million cycles of trouble-free service and include a drawer compulsion switch at no additional charge as a standard.

Manually operated Vasario cash drawers will provide over three hundred thousand trouble-free operations and are extremely cost effective for applications that require a manually activated solution.

- ◆ Two year limited warranty
- ◆ Lock conveniently located in the center of the drawer front
- ◆ Standard drawer compulsion switch
- ◆ Attractive and durable powder coat paint finish
- ◆ Durable steel construction with a roller bearing suspension system
- ◆ A variety of styles, sizes, colors, interfaces and till configurations

Vasario™ Series

The affordable standard duty
cash drawer series from
APG Cash Drawer

Build on a Solid Foundation®



19" Wide Vasario™ Cash Drawers



The 19" wide footprint is the flagship of the Vasario series. Like all APG cash drawers, it is truly a "best of class" product. The 18.81" x 15.19" footprint is excellent for hospitality, outlet malls and many other applications. It includes many features typically found in more expensive cash drawers and is the perfect solution for applications that can be addressed with a standard duty cash drawer. Choose from the available options: colors, drawer front styles and interfaces to suit your specific needs.

- ❖ Dual media slots
- ❖ Four function lock located conveniently in the center of the drawer front
- ❖ Drawer compulsion switch indicates **closed** and **latched status**
- ❖ MultiPRO interface optimizes connectivity
- ❖ Additional popular interfaces available
- ❖ Choice of stainless steel or painted front
- ❖ Optional low cost till cover can be stored in the drawer
- ❖ 18.81" width x 15.19" depth footprint matches popular competitive products

Part Number Configurator

P/N Example: VB320-BG1915

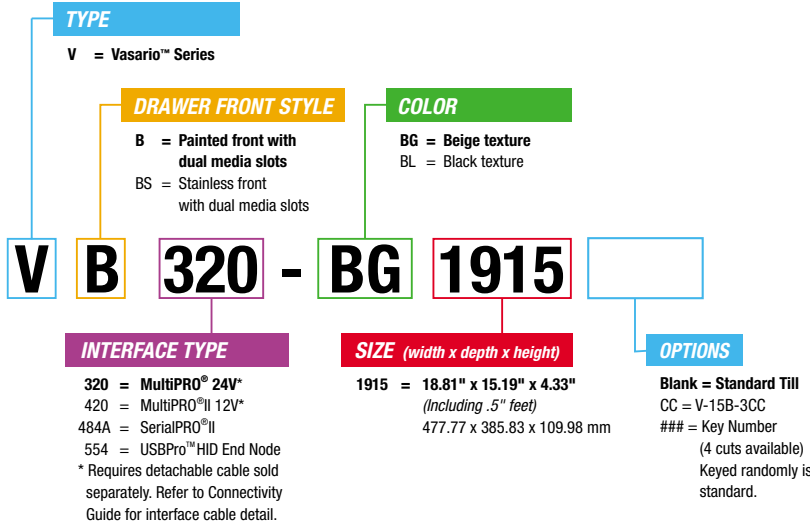

Accessories

See the Accessory Matrix for more options.

Standard Removable Till (included)

V-15B-3

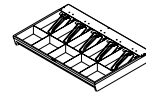

Optional Locking Till Cover

V-14B-5

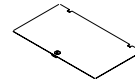

Optional Under Counter Mounting Bracket

V-27B-15

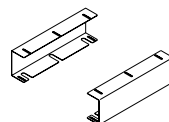

16" Wide Vasario™ Cash Drawers



The narrow 16" wide footprint of the 1616 and 1618 Vasario cash drawers provides a compact foundation for smaller terminals and POS applications with space constraints. The 16.20" x 16.33" or 16.20" x 18.33" are standard foundation sizes for electronic cash registers (ECRs). They are a great fit for small to mid-sized retail applications. The standard MultiPRO interface provides for easy configuration of these drawers to operate with popular receipt printers, ECRs and POS terminals. Choose the appropriate: sizes, drawer front styles, colors, interfaces and till configurations to suit your specific requirements.

- ❖ Dual media slots
- ❖ Four function lock located conveniently in the center of the drawer front
- ❖ Drawer compulsion switch indicates **closed** and **latched status**
- ❖ MultiPRO interface optimizes connectivity
- ❖ Additional popular interfaces available
- ❖ Choice of stainless steel or painted front
- ❖ Dual currency till option available for multiple currency applications

Part Number Configurator

P/N Example: VB320-BG1616

TYPE

V = Vasario™ Series

DRAWER FRONT STYLE

B = Painted front with dual media slots
BS = Stainless front with dual media slots

COLOR

BG = Beige texture
BL = Black texture

V **B** **320** - **BG** **1616**

INTERFACE TYPE

320 = MultiPRO® 24V*
420 = MultiPRO® II 12V*
484A = SerialPRO®II
554 = USBPro™HID End Node
* Requires detachable cable sold separately. Refer to Connectivity Guide for interface cable detail.

SIZE (width x depth x height)

1616 = 16.20" x 16.33" x 4.33"
(Including .5" feet)
411.48 x 414.78 x 109.98 mm
1618 = 16.20" x 18.33" x 4.33"
(Including .5" feet)
411.48 x 465.58 x 109.98 mm

OPTIONS

Blank = Standard Till
B5 = V-15B-5
B10 = V-15B-10
B12 = V-15B-12
B11 = VM-15B-5
= Key Number
(4 cuts available)
Keyed randomly is standard.

Accessories

See the Accessory Matrix for more options.

Standard Removable Till (included)

V-15B-2

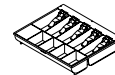

Optional Locking Till Cover

V-14B-4

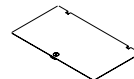

Optional Under Counter Mounting Bracket

V-27B-16 (1616)

V-27B-18 (1618)

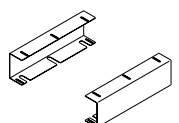
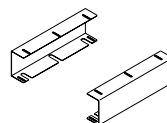

14" Wide Vasario™ Cash Drawers



The 14" wide footprint is the smallest of the Vasario cash drawer series. These sub-compact cash drawers are logical solutions for kiosk systems, concession sales, and similar applications where space is at a premium. Even though the 1416 is small in size, its standard four bill, five coin compartment till provides ample capacity. The MultiPRO interface optimizes connectivity flexibility.

- ❖ Drawer compulsion switch indicates **closed** and **latched status**
- ❖ MultiPRO interface optimizes connectivity
- ❖ Additional popular interfaces available
- ❖ Choice of stainless steel or painted front
- ❖ Four function lock located conveniently in the center of the drawer front

Trim off

Part Number Configurator

Accessories

P/N Example: VP320-BG1416

TYPE

V = Vasario™ Series

DRAWER FRONT STYLE

P = Painted drawer front
S = Stainless front

COLOR

BG = Beige texture
BL = Black texture

V **P** **320** - **BG** **1416**

INTERFACE TYPE

320 = MultiPRO® 24V*
420 = MultiPRO® II 12V*
484A = SerialPRO®II
554 = USBPro™ HID End Node
* Requires detachable cable sold separately. Refer to Connectivity Guide for interface cable detail.

SIZE (width x depth x height)

1416 = 13.80" x 16.33" x 4.00"
(Including .5" feet)
350.52 x 414.78 x 101.60 mm

OPTIONS

Blank = Standard Till
B4 = V-15B-4A
= Key Number
(4 cuts available)
Keyed randomly is standard.

See the Accessory Matrix for more options.

Standard Removable Till (included)

V-15B-1A

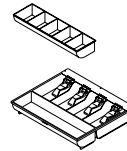

Optional Locking Till Cover

V-14B-3A

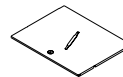

Optional Under Counter Mounting Bracket

V-27B-16

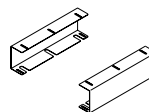

Manually Operated Vasario™ Cash Drawers



For many applications, a manually operated cash drawer will satisfy cash handling requirements. The 13.80" x 16.33" and 16.20" x 16.33" sizes cater to concession sales, seasonal departments and hospitality applications. These cost effective, convenient, push button cash drawers will provide a useful life of at least 300,000 trouble free operations. Choose the size, color and till configuration to meet your specific needs.

- ❖ Two function lock located conveniently in the center of the drawer front
- ❖ Choice of beige or black
- ❖ Keylock secures unattended cash drawer
- ❖ Other applications include:
 - Hotels
 - Bait Shops
 - Petty Cash
 - Nonprofits
 - Medical / Dental offices

Trim off

Part Number Configurator

Accessories

P/N Example: VP101-BG1416

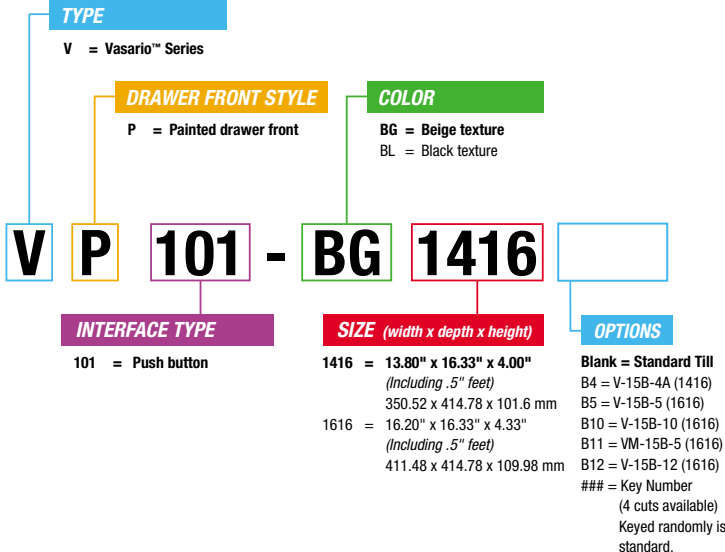

See the Accessory Matrix for more options.

Standard Removable Tills (included)

V-15B-1A (1416)

V-15B-2 (1616)

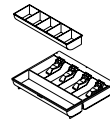

Optional Locking Till Covers

V-14B-3A (1416)

V-14B-4 (1616)



Optional Under Counter Mounting Bracket

V-27B-16

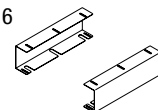











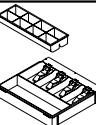



APG Cash Drawer



www.apgcd.com

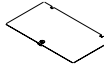

Accessory Matrix

Tills					Till Covers				
Drawer Width	Part # Designation	# Bills x # Coins	Till Options*	Till Drawings	Spare Till Part Number † (bulk packed 10 Min.)	Features & Till Dimensions W" x L" x H" (Millimeters)	Till Cover † Part Number (Keyed alike)	Till Covers	Till Cover Dimensions W" x L" (Millimeters)
14" wide	4 x 5		Standard		V-15B-1A	Adjustable bill widths Removable coin tray 12.65 x 11.70 x 2.20 (321.31 x 297.18 x 55.88)	V-14B-3A		12.65 x 10.44 (321.31 x 265.18)
1416	4 x 8		-B4		V-15B-4A	Adjustable bill widths Removable coin tray 12.65 x 11.70 x 2.20 (321.31 x 297.18 x 55.88)			
16" wide	5 x 5		Standard		V-15B-2	Fixed bill & coin areas Plastic bill hold downs 14.20 x 12.05 x 2.35 (360.68 x 306.07 x 59.69)	V-14B-4		14.20 x 10.90 (360.68 x 276.86)
1616 or 1618	4 x 8		-B5		V-15B-5	Adjustable bill widths Adjustable coin widths 14.20 x 12.65 x 2.40 (360.68 x 321.31 x 60.96)	V-14B-6		14.20 x 11.50 (360.68 x 292.10)
	5 x 8		-B10		V-15B-10	Adjustable bill widths Adjustable coin widths 14.20 x 12.65 x 2.40 (360.68 x 321.31 x 60.96)			
	5 x 10		-B12		V-15B-12	Adjustable bill widths Adjustable coin widths 14.20 x 12.65 x 2.40 (360.68 x 321.31 x 60.96)			
	8 x 8		-B11		VM-15B-5	Dual currency style Adjustable coin widths Euro ready 14.20 x 12.65 x 2.40 (360.68 x 321.31 x 60.96) 			
18.8" wide	5 x 5		Standard		V-15B-3	Fixed bill & coin areas Wire bill hold downs 16.00 x 10.95 x 2.15 (406.40 x 278.13 x 54.61)	V-14B-5		15.40 x 8.80 (391.16 x 223.52)
1915			-CC		V-15B-3CC	Fixed bill & coin areas Wire bill hold downs 16.00 x 10.95 x 2.15 (406.40 x 278.13 x 54.61)			

Under Counter Mounting Brackets

1416 1616	N/A	N/A		V-27B-16	Under counter mounting bracket kit 2.44 x 16.00 x 4.28 (61.98 x 406.40 x 108.58)
1618	N/A	N/A		V-27B-18	Under counter mounting bracket kit 2.44 x 18.00 x 4.28 (61.98 x 457.20 x 108.58)
1915	N/A	N/A		V-27B-15	Under counter mounting bracket kit 2.44 x 15.00 x 4.28 (61.98 x 381.00 x 108.58)

Standard till for listed cash drawer

* Cash Drawer Part Number Till Option Identifier
(Use this to configure which till you prefer.)

† To order individually boxed, change the V to VPK and add -BX to the end

Limited Warranty:

A two (2) year limited warranty will apply to any electrical or mechanical components found to be defective in material or workmanship. All warranty parts or repairs will be made F.O.B. APG's facility.

APG® Cash Drawer, the APG cash drawer logo, Build on a Solid Foundation®, POS-Organizer®, SerialPRO®, MultiPRO® and POS-Partner® system are all registered trademarks of APG Cash Drawer.

© Copyright 2003 APG CASH DRAWER

M-43-026 Rev C

A Division of Upper Midwest Industries, Inc.
5250 Industrial Blvd N.E.
Minneapolis, Minnesota 55421-1012
Phone: 763-571-5000 • Fax: 763-571-5771
Web address: www.apgcd.com

